

30 min

**ERC**

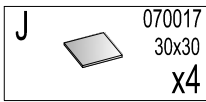

No	Size/MaB (mm)	Qty	✓	No	Size/MaB (mm)	Qty	✓
1C	364x364x15	1		11C	537x40x40	1	
2C	400x63x18	2		12C	537x40x40	1	
3C	364x63x18	2		13C	537x40x40	1	
4C	318x22x22	2		14C	350x80x14	1	
5C	320x160x18	1		15C	350x80x14	1	
6C	320x160x18	2		16C	286x80x14	1	
7C	320x73x18	1		17C	314x104x18	1	
8C	319x36x18	1		18C	342x295x3	1	
9C	364x364x15	1		7G	319x36x18	4	
10C	537x40x40	1					

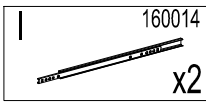
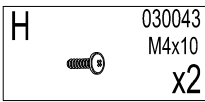
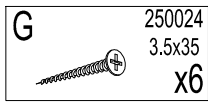
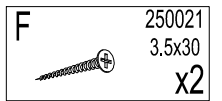
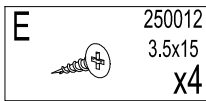
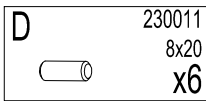
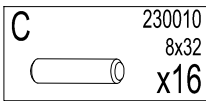
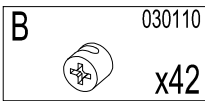
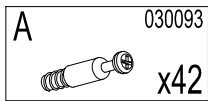
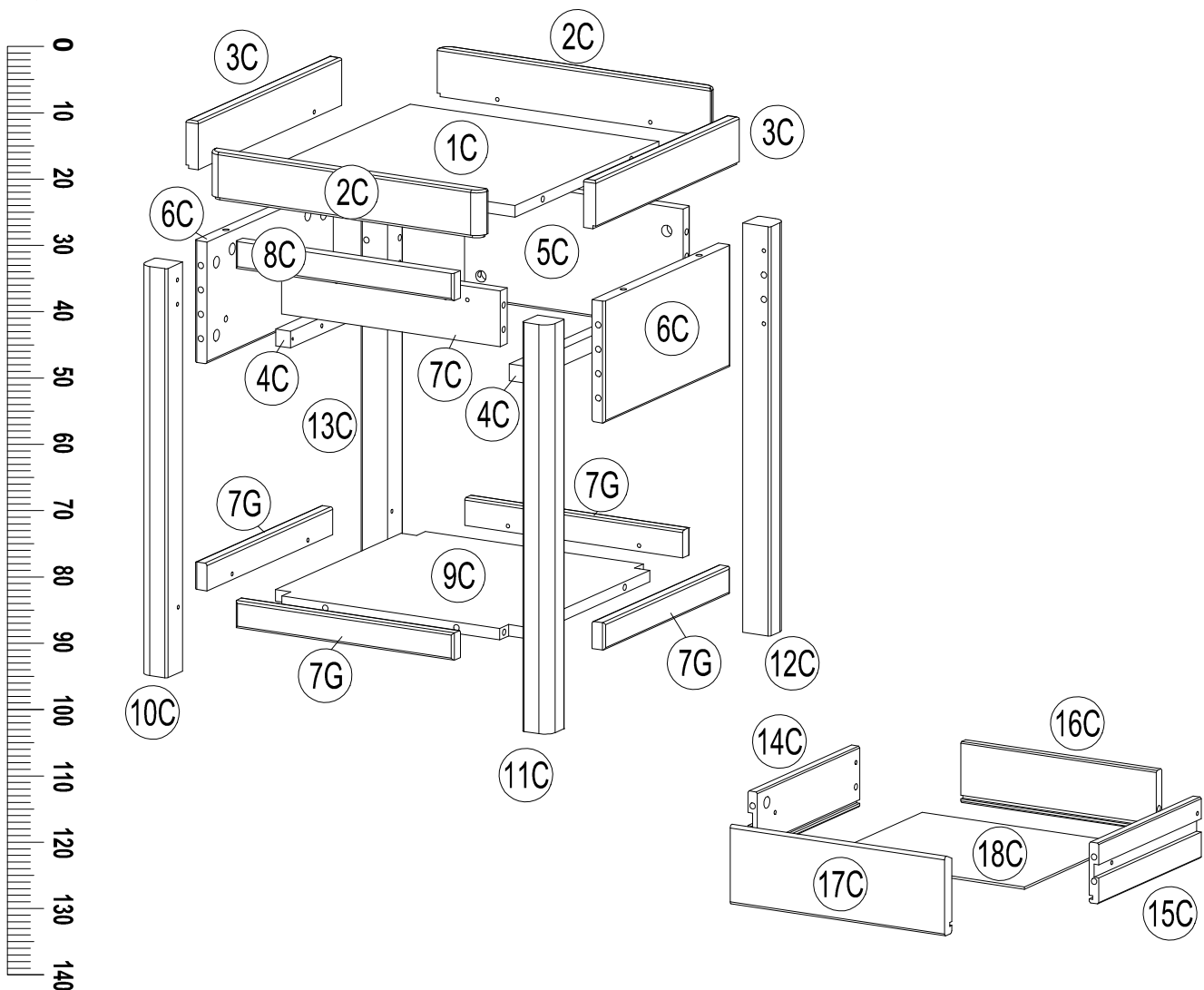

**1**

<b>A</b>	030093 x40
<b>C</b>	230010 8x32 x12
<b>D</b>	230011 8x20 x2
<b>F</b>	250021 3.5x30 x2

Assembly diagram for step 1 showing the installation of screws A, C, D, and F into various components (2c, 3c, 5c, 6c, 7c, 7G, 8c, 10c, 11c, 12c, 13c). Includes a warning diagram showing correct and incorrect screw placement and a detail of screw C being inserted into a hole.

**2**

<b>B</b>	030110 x16
----------	---------------

Assembly diagram for step 2 showing the installation of washers B into components 1c, 2c, 3c, 4c, 7G, and 9c. Includes a detail of a washer B being inserted into a hole.

**3**

<b>B</b>	030110 x8
----------	--------------

Assembly diagram for step 3 showing the installation of washers B into components 6c, 10c, 11c, 12c, and 13c. Includes a detail of a washer B being inserted into a hole.

**4**

<b>D</b>	230011 8x20 x4
<b>E</b>	250012 3.5x15 x4
<b>G</b>	250024 3.5x35 x4
<b>I</b>	160015 x2
<b>J</b>	070017 30x30 x4

Assembly diagram for step 4 showing the installation of screws D, E, G, I and components J into the main assembly. Includes two circular diagrams showing the correct orientation for component J.

