

Art. Nr. 89526962;48272540;18725055;68805201;
45549256;20132203;86617811;54009407 LKZ 40947

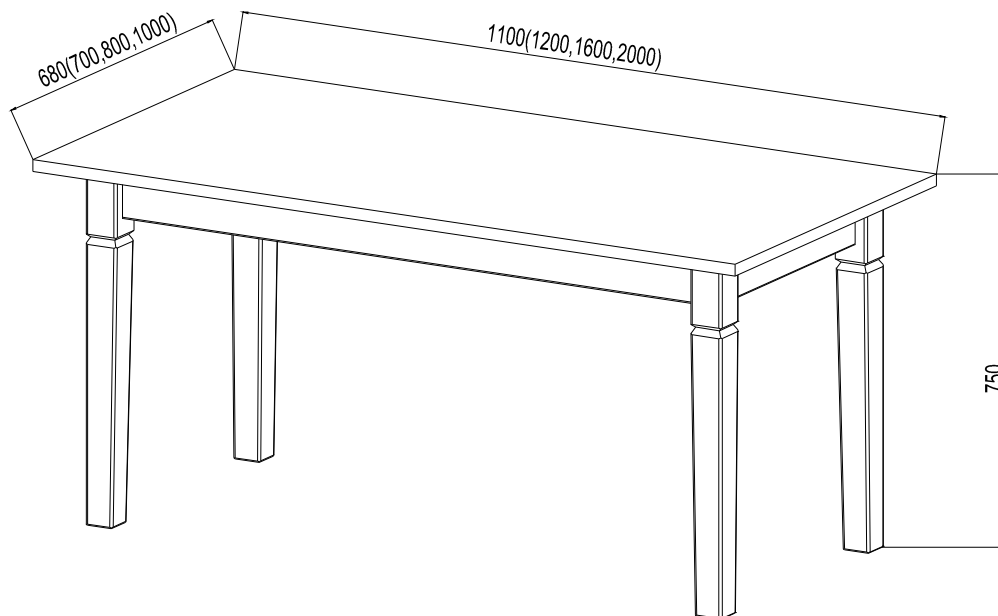

- | | | | |
|-----------|------------------------------------|-----------|--------------------------------|
| D | Montageanleitung | GB | Assembly instructions |
| FR | Notice de montage | IT | Istruzioni di montaggio |
| NL | Handleiding voor de montage | PL | Instrukcja montażu |
| CZ | Montážní návod | SK | Návod na montáž |
| HU | Szerelési útmutató | RO | Instrukțiuni de montaj |
| TR | Montaj talimatı | RU | Инструкция по монтажу |

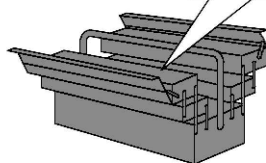
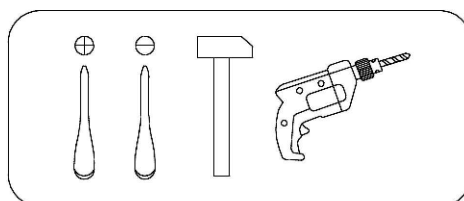
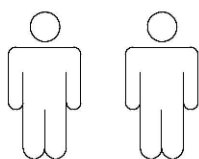

0
10
20
30
40
50
60
70
80
90
100
110
120
130
140
150
160
170
180
190
200

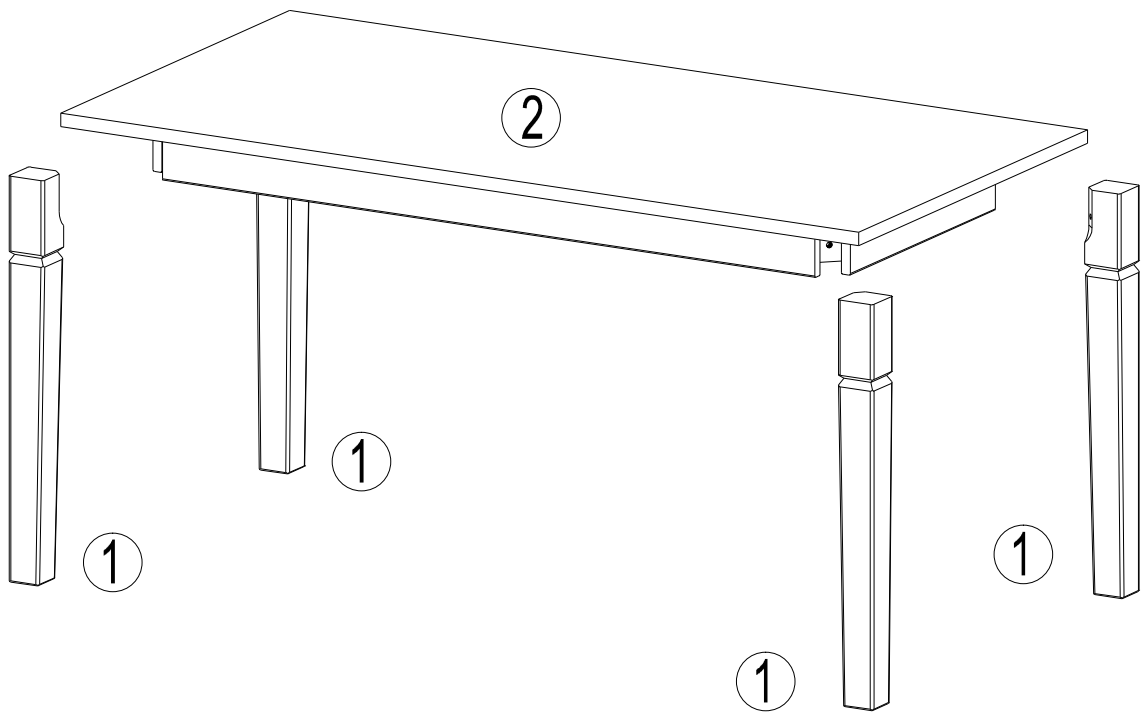

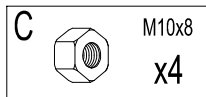
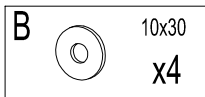
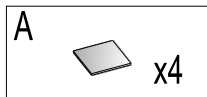

Art. Nr. 89526962;48272540

No	Size/MaB (mm)	Qty	✓	No	Size/MaB (mm)	Qty	✓
1	726x70x70	4		2	1100x680x124	1	

Art. Nr. 18725055;68805201

No	Size/MaB (mm)	Qty	✓	No	Size/MaB (mm)	Qty	✓
1	726x70x70	4		2	1200x700x124	1	

Art. Nr. 45549256;20132203

No	Size/MaB (mm)	Qty	✓	No	Size/MaB (mm)	Qty	✓
1	726x70x70	4		2	1600x800x124	1	

Art. Nr. 86617811;54009407

No	Size/MaB (mm)	Qty	✓	No	Size/MaB (mm)	Qty	✓
1	726x70x70	4		2	2000x1000x124	1	

1

