

РЕСПУБЛИКА БЕЛАРУСЬ
ОТКРЫТОЕ АКЦИОНЕРНОЕ
ОБЩЕСТВО "ФАНДОК"

*Стол письменный
Фокстрот М 003
1369xH775x700мм
Инструкция по сборке*

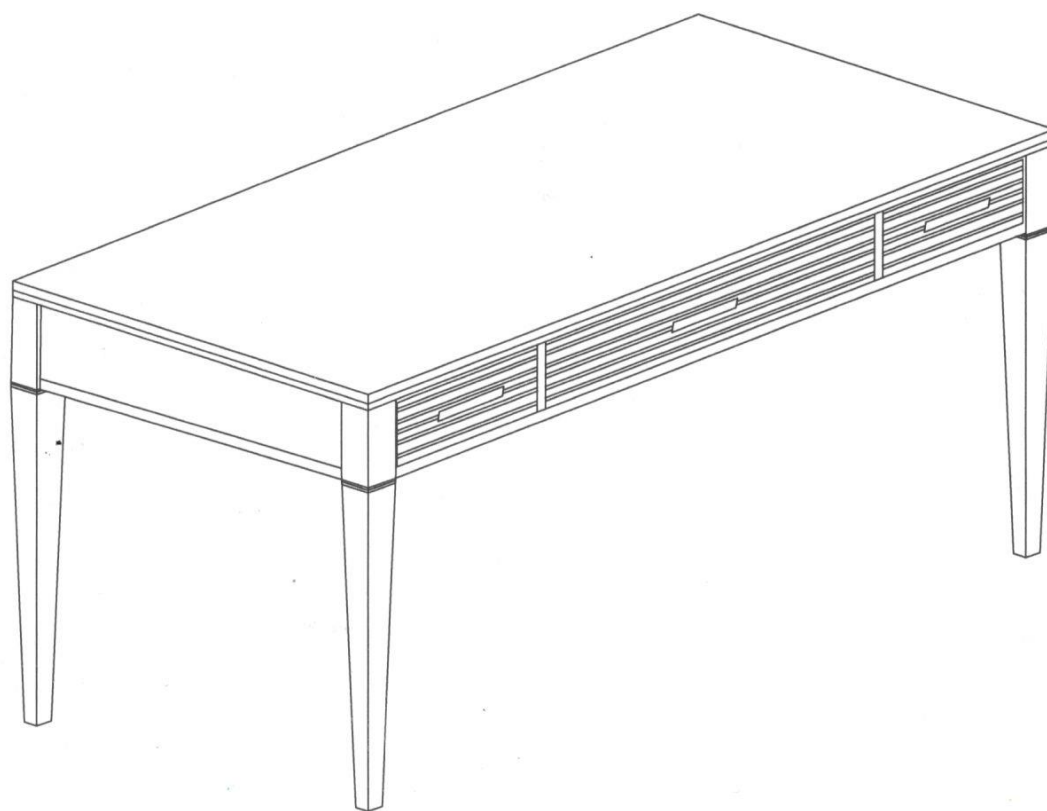

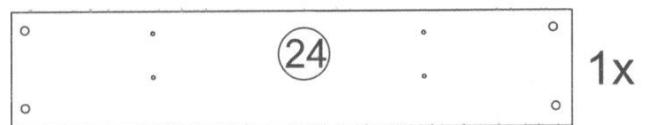

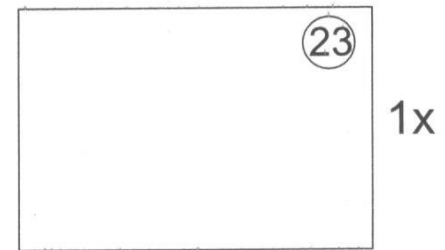
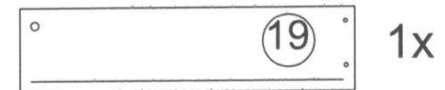
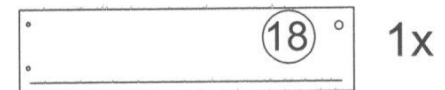
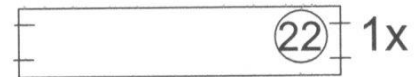
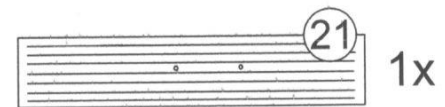
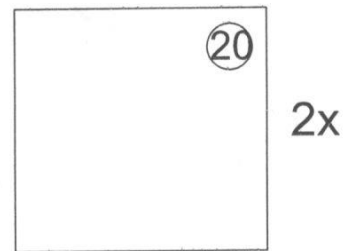
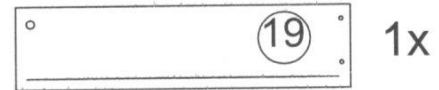
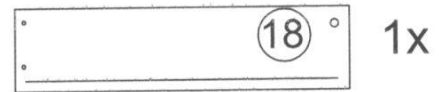
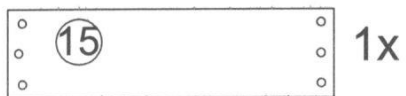
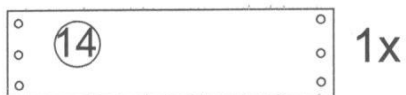
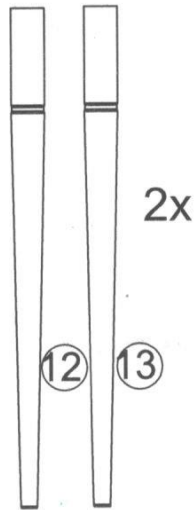
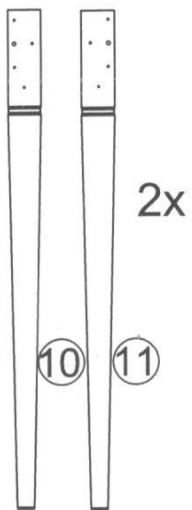
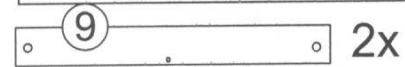
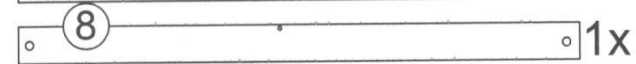
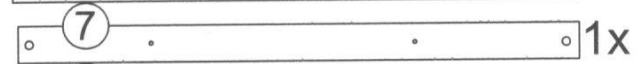
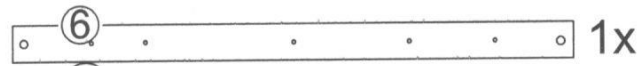
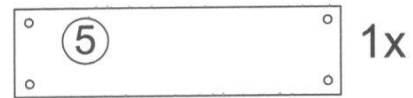
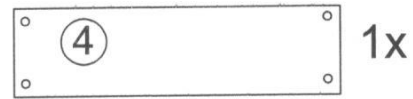
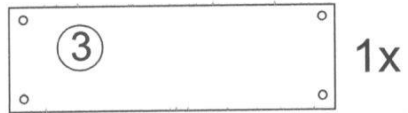
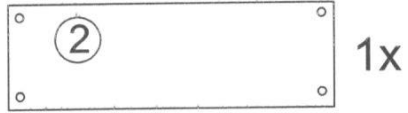
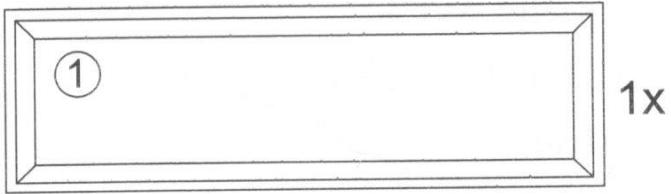
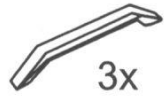
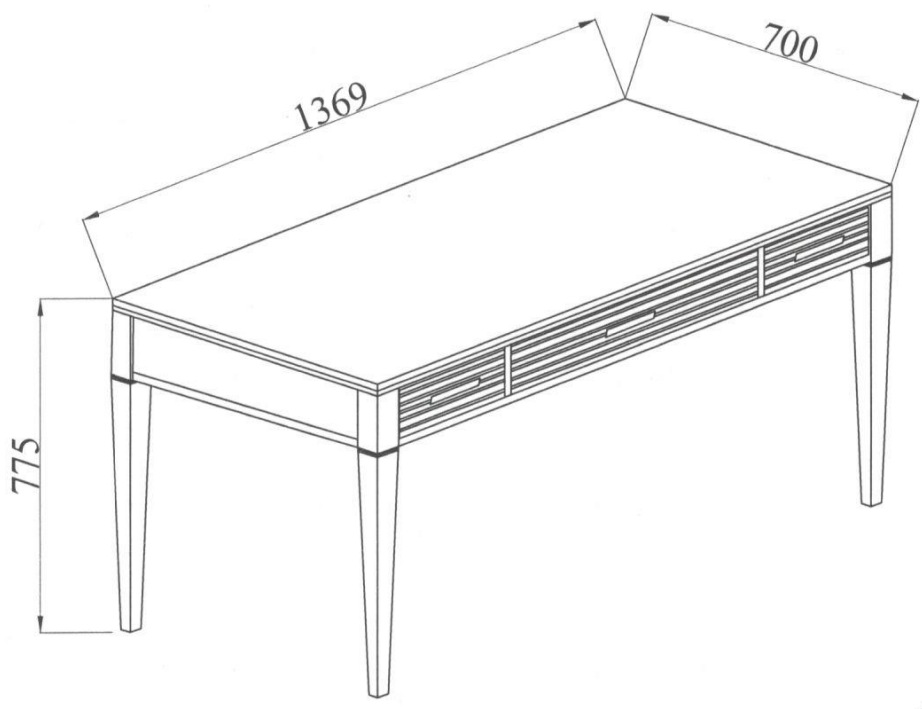

3x



6x

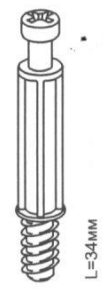

L=34MM

38x



Ø15x12,5

38x



Ø8x35

14x



1x

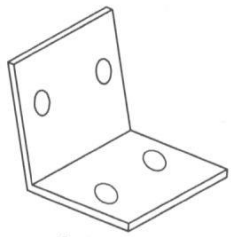

3x

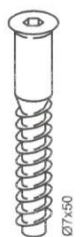

Ø7x50

7x

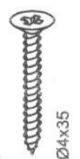

Ø4x35

15x



Ø4x30

10x



Ø4x16

48x



2x20

12x



3xL=550MM

Поз.	Размер,мм	Кол-во	Пакет
1	1369x700x29	1	1/2
2	600x123x17	1	1/2
3	600x123x17	1	1/2
4	675x106x17	1	1/2
5	675x106x17	1	1/2
6	1269x50x17	1	1/2
7	1269x50x17	1	1/2
8	1269x50x17	1	1/2
9	600x50x17	2	1/2
10	746x50x50	1	2/2
11	746x50x50	1	2/2
12	746x50x50	1	2/2
13	746x50x50	1	2/2
14	600x123x17	1	1/2
15	600x123x17	1	1/2
16	279x100x18	2	1/2
17	238x51x18	2	2/2
18	540x70x18	3	2/2
19	540x70x18	3	2/2
20	252x546x4	2	1/2
21	659x100x18	1	2/2
22	618x51x18	1	1/2
23	632x546x4	1	1/2
24	1269x123x17	1	1/2

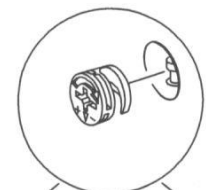
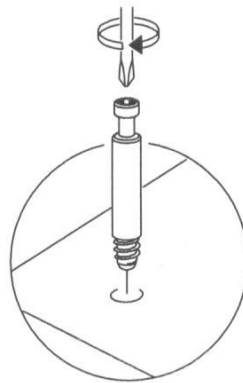
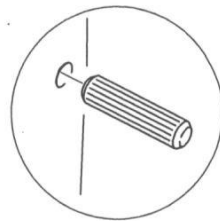
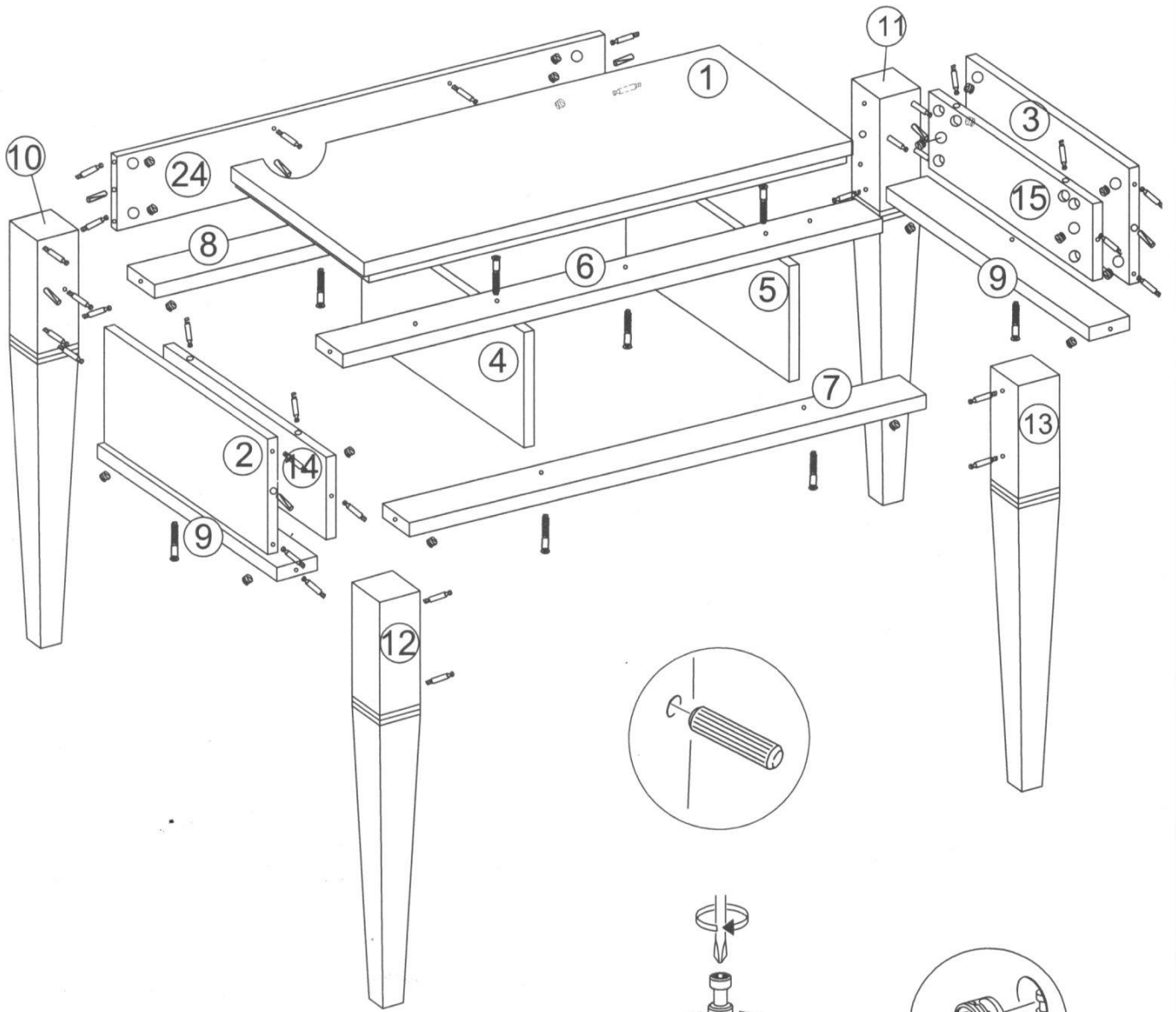

L=34MM

32x



32x

Ø15x12,5

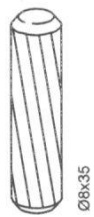

8x

Ø8x35

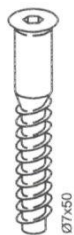

7x

Ø7x50

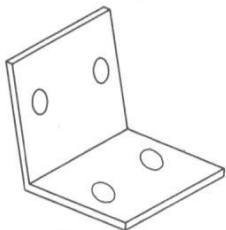
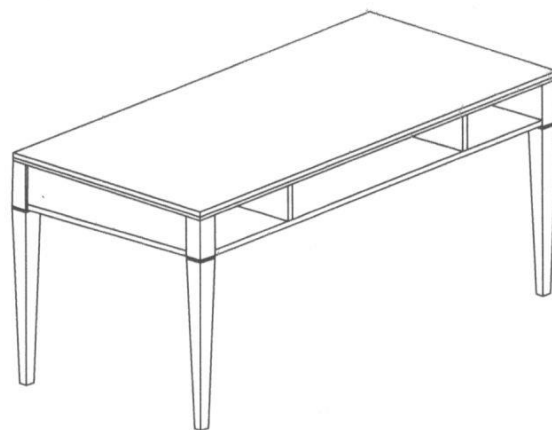
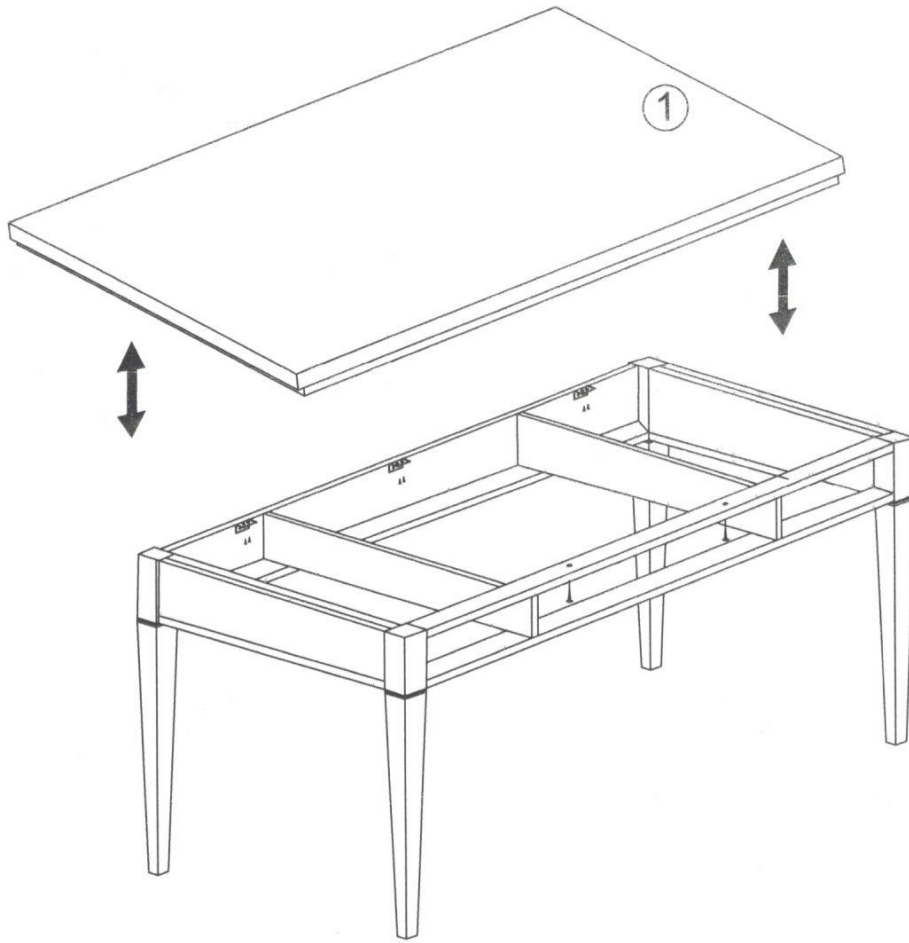

3x



12x





Ø4x16

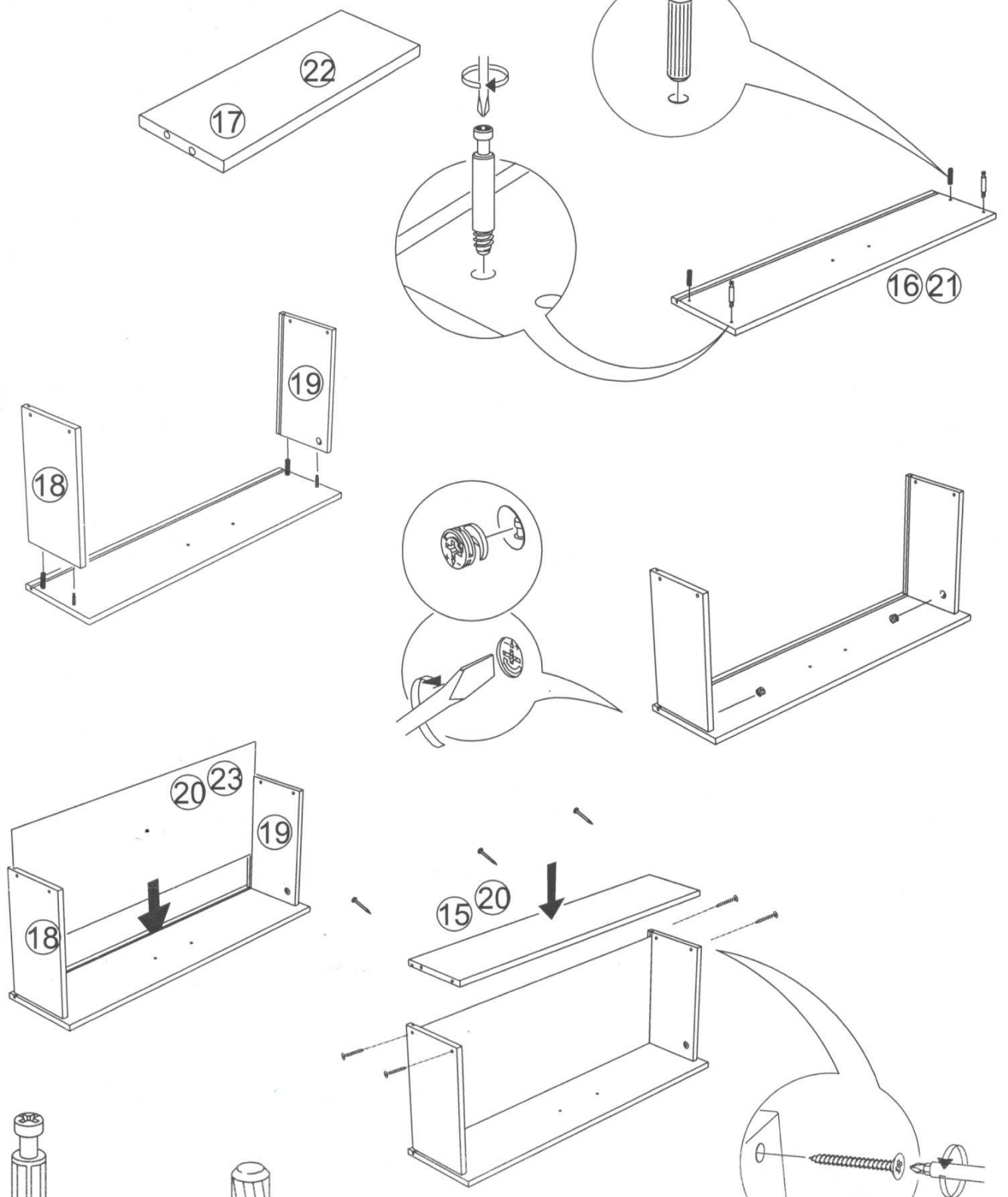

2x

Ø4x30



-  L=34mm
 -  Ø15x12
 -  Ø6x35
 -  Ø4x35
 -  2x20
- 6x 6x 6x 12x 12x

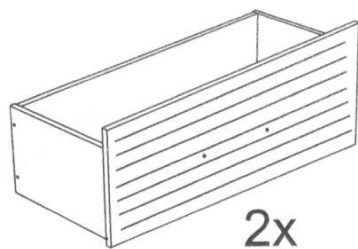

2x

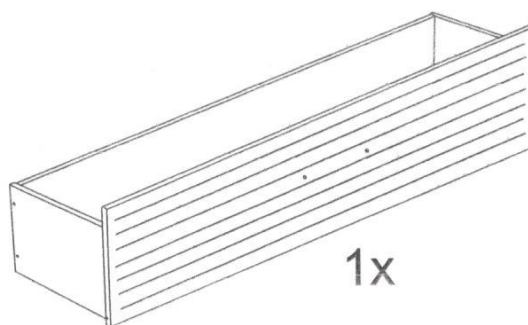

1x

1. Установка направляющих на боковых стенках корпуса в соответствии со схемой присадки

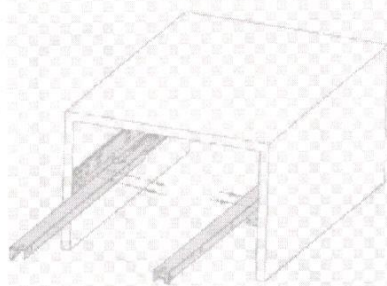

2. Фиксаторы, левый и правый, располагаясь на дне ящика, закрепляются саморезами с фасадом и с боковыми стенками ящика.



3. Выдвиньте подвижные элементы направляющих, вставьте ящик и задвиньте до щелчка. Крючки направляющих должны войти в зацепление с отверстиями в задней стенке ящика

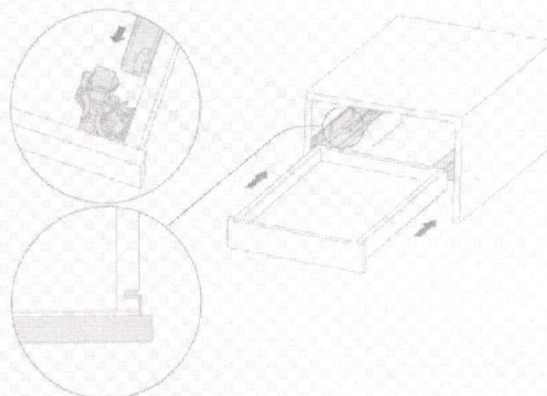

4. Регулировка фасада по вертикали. Надавите и поворачивайте.

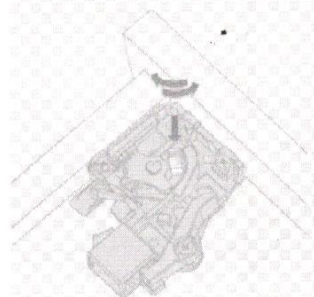

5. Демонтаж ящика. Выдвиньте ящик, нажмите одновременно на рычажки фиксаторов и снимите ящик с направляющих.

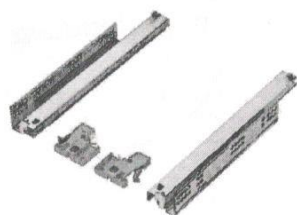
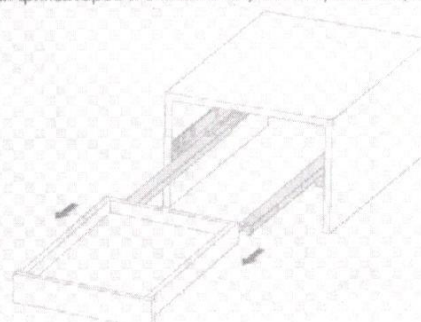
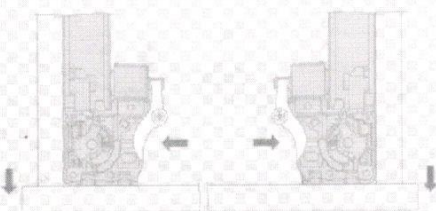

3x



Ø4x16

24x

8

